









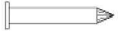

COMODA CHIGAGO 100

Parte do Produto

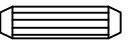
- | | |
|-------------------------|--------------------------------|
| 1 Lateral direita (1x) | 8 Frente de gaveta (4x) |
| 2 Lateral esquerda (1x) | 9 Lateral de gaveta dir (4x) |
| 3 Tampo (1x) | 10 Lateral de gaveta esq (4x) |
| 4 Base (1x) | 11 Contra fundo de gaveta (4x) |
| 5 Pés (4x) | 12 Fundo de gaveta(4x) |
| 6 Trava superior (1x) | 13Trava da gaveta (4x) |
| 7 Trava central (1x) | 14 Fundo da comoda (2x) |

Componentes

- | | |
|---|---|
| 
A - Parafuso 7x50 (8x) | 
G - Parafuso 3,5x16 ch (16x) |
| 
B - Parafuso 3,5x16 flang (8x) | 
H - Dispositivo trapézio (12x) |
| 
C - Parafuso 3,5x12 (32x) | 
I - Prego kit (60x) |
| 
D - Cantoneira metal (8x) | 
J - Corrediça 400mm (4x par) |
| 
E - Cavilha 8x30 (24x) | 
K - Puxador (4x par) |
| 
F - Parafuso 3,5x25 (12x) | 
L - Perfil H 895 (1x) |
| 
M - Parafuso 4x30 (4x) | |

1- Montagem

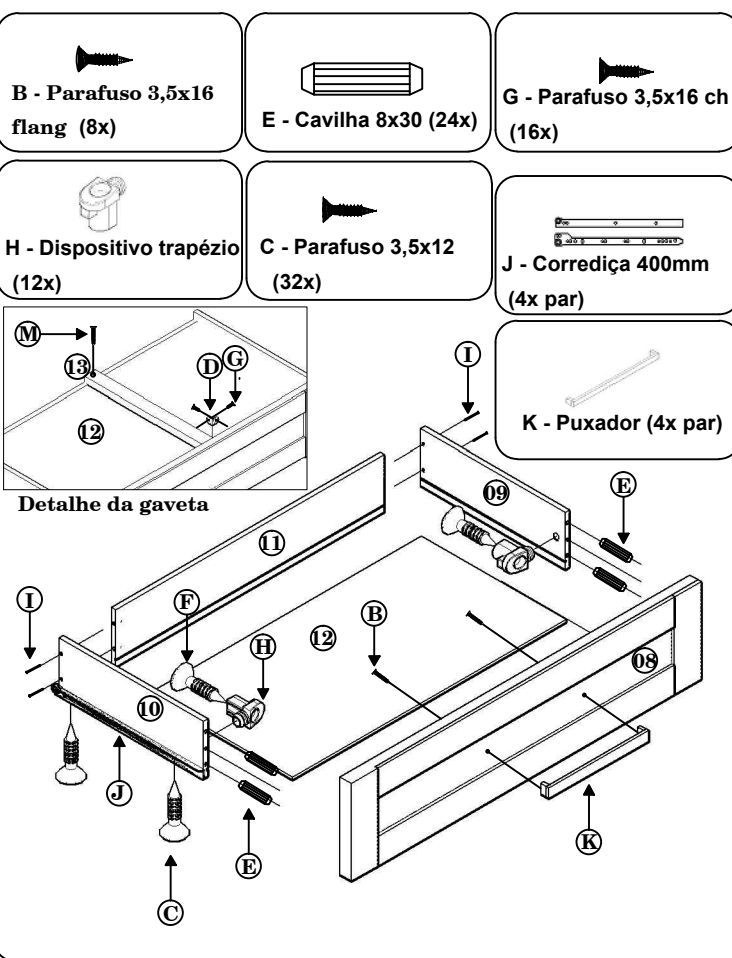

2- Montagem

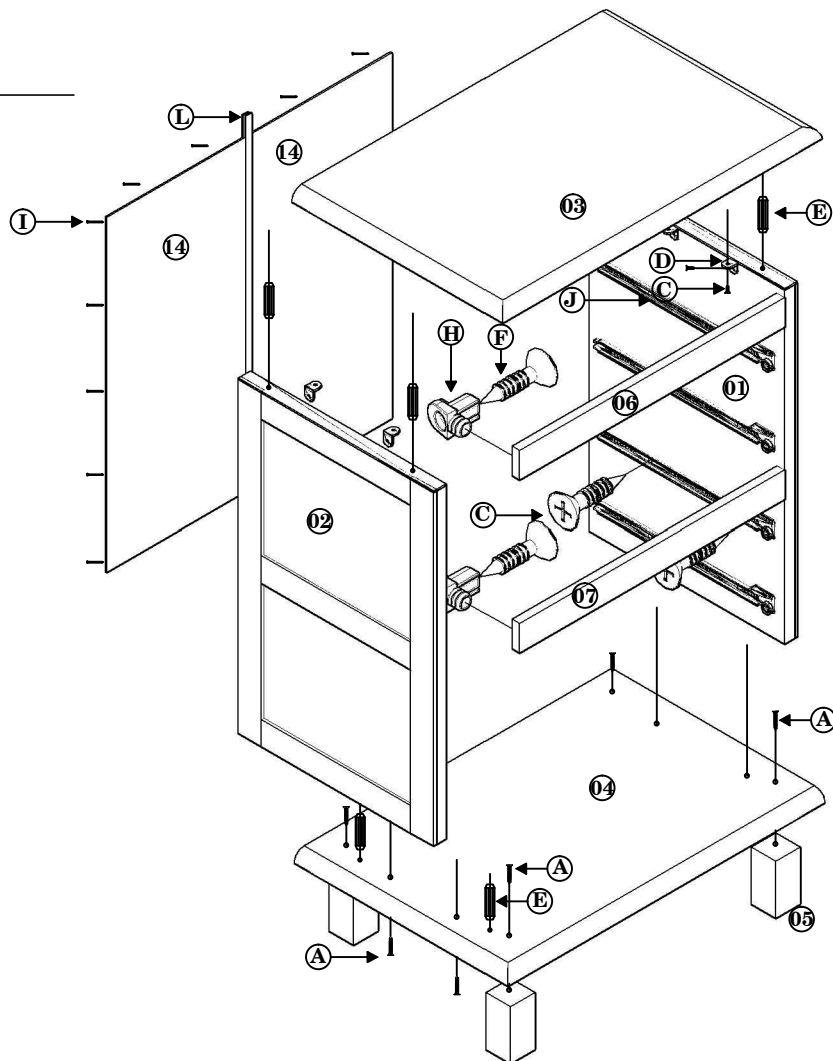

- 
A - Parafuso 7x50 (8x)

- 
D - Cantoneira metal (8x)

- 
E - Cavilha 8x30 (24x)

- 
I - Prego kit (60x)

- 
J - Corrediça 400mm (4x par)

- 
L - Perfil H 895 (1x)

- 
C - Parafuso 3,5x12 (32x)